



Standards

EN140: 1998 Mask Body
EN14387: 2004 + A1: 2008 A1P3 R D
(suited for organic gases and dust)
CE 2797

Efficiency

P3 >99,95% for 0,3 µm particulate
At 1000 ppm:
A1 >70 minutes cyclohexane (C₆H₁₂)

Weight

Mask + Filter: net (S/M) 267 g; (M/L) 271 g
gross (S/M) 337 g; (M/L) 341 g
Filter: net 90 g each; both net 180 g, gross 208 g

Shelf Live

3 years (mask & filters) See storage conditions on Instructions for Use.
Filters are re-usable and changeable.

Material

- **Mask:** Medical grade TPE Conforms to ISO 10993-10: 2010 for irritations. Mask body latex and silicone free, odour free. Valve Body in Nylon, Inhalation/Exhalation diaphragm in Silicone. 4 point adjustable elasticated head and neck strap with comfort pad in TPE.
- **Gas Filters:** Activated carbon sealed into a ABS Shell.
- **Particulate filters:** Mechanical type multi-layer HESPA Synthetic media with TPE flexible overmolded / encapsulated. Particulate filters are integrated permanently with the carbon element.

Production

United Kingdom
100% of filters NaCl Tested

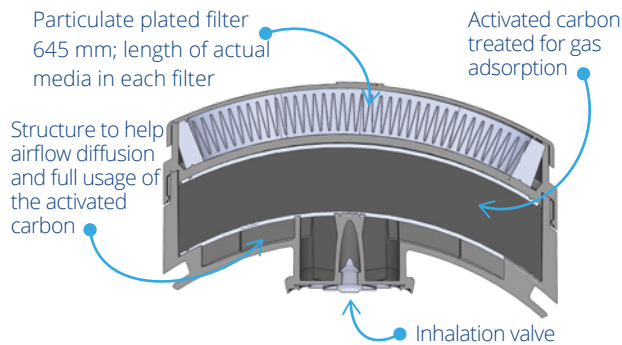

Code	Description	Quantity
SPR338 (S/M) SPR503 (M/L)	Elipse Half Mask complete with A1P3 filters	10 pcs. per box
SPR341	Elipse A1P3 replacement filters	10 sets of 2 pcs. per box
SPM008	Elipse Low Profile Mask Carry Case (Belt holder)	10 sets per box
SPM414	Portacount Face Fit Kit adaptor	10 sets per box
SPM420	Kit of Prefilter Kits - 2 holder and 10 pads	10 kits per box
SPM421	Kit of Prefilter - 20 pads	10 kits per box

Applications - Organic gases, dust, mist and fumes

Welding

Metal Fumes and Dust in confined space (gas welding)

Construction

Paint, Moulds.

Car & Ship Repair

Epoxyte, Paint, Solvents

Manufacturing

Solvents, various Organic Gases

Agriculture

Pesticides